



AV2.2P AV2.4P

PROFESSIONAL AUDIO AMPLIFIER

OPERATION MANUAL

AV2.2P | AV2.4P

PROFESSION
AUDIO AMP

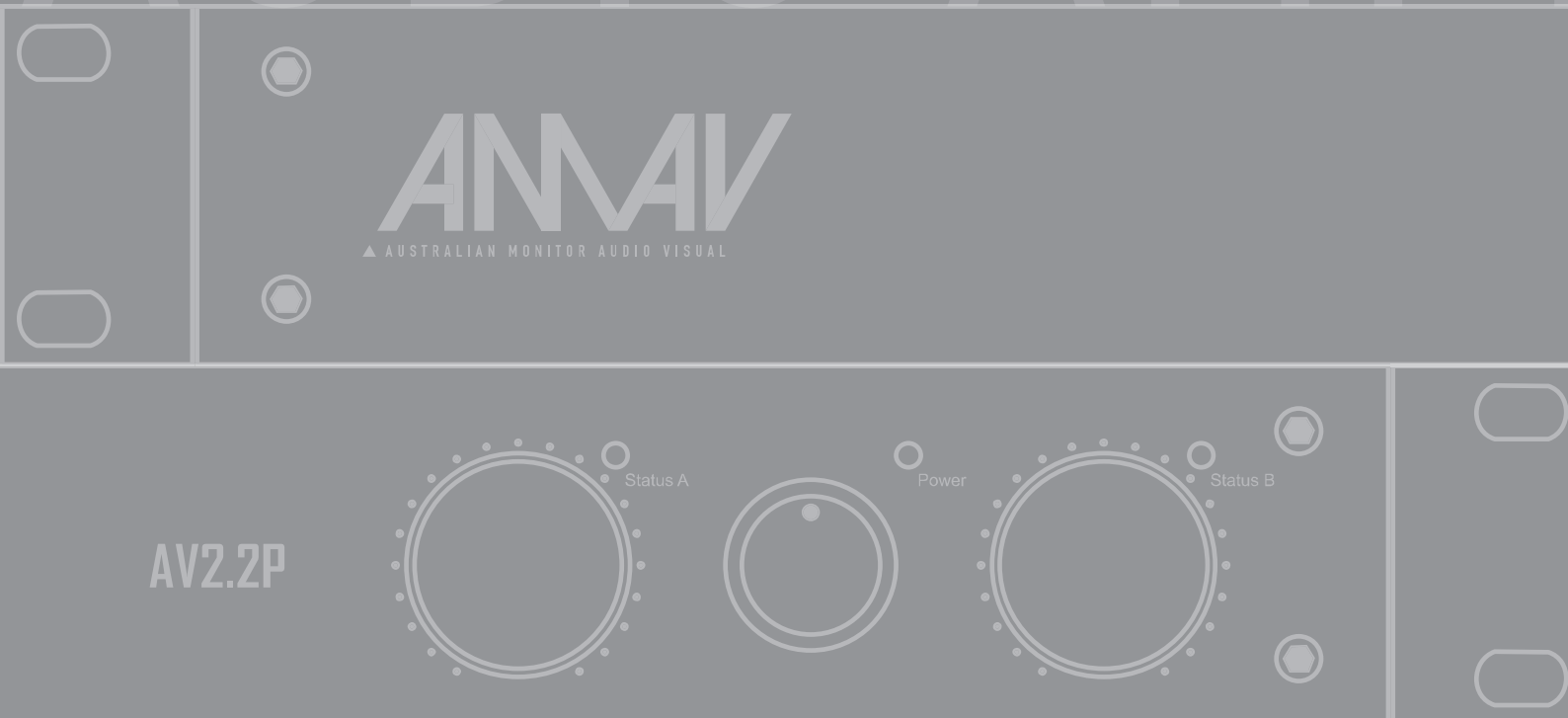



IMPORTANT SAFETY INFORMATION



This operation manual contains important information regarding safety precautions, installation, performance, operation and maintenance of your AMAV power amplifier. You should familiarize yourself with the contents of this manual before operating your amplifier.

1. Save the carton and packing material even if the equipment has arrived in good condition. Should you ever need to ship the unit, use only the original factory packing.
2. Read all documentation before operating your equipment. Retain all documentation for future reference.
3. Follow all instructions printed on unit chassis for proper operation.
4. Do not spill water or other liquids into or on the unit, or operate the unit while standing in liquid.
5. Make sure power outlets conform to the power requirements listed on the back of the unit.
6. Do not use the unit if the electrical power cord is frayed or broken. The power supply cords should be routed so that they are not likely to be walked on or pinched by items placed upon or against them, paying particular attention to cords and plugs, convenience receptacles, and the point where they exit from the appliance.
7. Always operate the unit with the AC ground wire connected to the electrical system ground. Precautions should be taken so that the means of grounding of a piece of equipment is not defeated.
8. Mains voltage must be correct and the same as that printed on the rear of the unit. Damage caused by connection to improper AC voltage is not covered by any warranty.
9. Have gain controls on amplifiers turned down during power-up to prevent speaker damage if there are high signal levels at the inputs.
10. Power down & disconnect units from mains voltage before making connections.
11. Never hold a power switch in the "ON" position if it won't stay there itself!
12. Do not use the unit near stoves, heat registers, radiators, or other heat producing devices.
13. Do not block fan intake or exhaust ports. Do not operate equipment on a surface or in an environment which may impede the normal flow of air around the unit, such as a bed, rug, weathersheet, carpet, or completely enclosed rack. If the unit is used in an extremely dusty or smoky environment, the unit should be periodically "blown free" of foreign matter.
14. Do not remove the cover. Removing the cover will expose you to potentially dangerous voltages. There are no user serviceable parts inside.
15. Do not drive the inputs with a signal level greater than that required to drive equipment to full output.
16. Do not connect the inputs / outputs of amplifiers or consoles to any other voltage source, such as a battery, mains source, or power supply, regardless of whether the amplifier or console is turned on or off.
17. Do not run the output of any amplifier channel back into another channel's input. Do not parallel- or series-connect an amplifier output with any other amplifier output. Australian Monitor Inc is not responsible for damage to loudspeakers for any reason.
18. Do not ground any red ("hot") terminal. Never connect a "hot" (red) output to ground or to another "hot" (red) output!
19. Non-use periods. The power cord of equipment should be unplugged from the outlet when left unused for a long period of time.
20. Service Information Equipment should be serviced by qualified service personnel when:
 - A. The power supply cord or the plug has been damaged.
 - B. Objects have fallen, or liquid has been spilled into the equipment
 - C. The equipment has been exposed to rain
 - D. The equipment does not appear to operate normally, or exhibits a marked change in performance
 - E. The equipment has been dropped, or the enclosure damaged.

THIS SAFETY INFORMATION IS OF A GENERAL NATURE AND MAY BE SUPERSEDED BY INSTRUCTIONS CONTAINED WITHIN THIS MANUAL

INTRODUCTION AND CONTENTS

Congratulations on choosing Australian Monitor for you professional amplification requirements.

The AMAV stereo power amplifiers are designed for the demanding commercial audio-visual Market. Two amplifier models are available within the AMAV range. The AV2.2P delivers 100 watts per channel at 4 ohms from an elegant, 1RU slim line package. The AV2.4P delivers 200 watts per channel at 4 ohms from an elegant, 2RU package. Both amplifiers feature front panel dual colour status LEDs, on board limiter, ground lift switch and the option of bridged operation.

Add to this the AV2.2P and AV2.4P's whisper quiet operation, achieved via its convection cooled design and you have an elegant, high quality audio amplifier.

The AV2.2P and AV2.4P offers the power and the features demanded by any quality AV application.

INTRODUCTION	3
FEATURES	4
CONTROLS, CONNECTORS AND INDICATORS	
FRONT PANEL	5
REAR PANEL	6
INSTALLATION	7
OPERATION	9
MAINTENANCE	10
BLOCK DIAGRAM	10
SPECIFICATIONS	11

AUS, EUR, USA
Rev A: Mar 2007



WARNING!

TO REDUCE THE RISK OF FIRE OR ELECTRIC SHOCK
DO NOT EXPOSE THIS EQUIPMENT TO RAIN OR MOISTURE.



This symbol is intended to alert the user to the presence of uninsulated "dangerous voltage" within the products enclosure that may be of sufficient magnitude to constitute a risk of electric shock to persons.



This symbol is intended to alert the user to the presence of important operational and maintenance (servicing) instructions in the literature accompanying the appliance.

Caution:

To prevent electric shock do not use this (polarised) plug with an extension cord, receptacle or other outlet unless the blades can be fully inserted to prevent blade exposure. To prevent electric shock, match wide blade of plug to wide slot, fully insert.

FEATURES

- > Custom designed, heavy duty steel chassis.
 - > Rear rack mount ears.
 - > Symmetrical layout - even weight distribution.
 - > High current power supply.
 - > High efficiency toroidal mains transformer.
 - > Silent convection cooling.
 - > Balanced inputs and buffered attenuators.
 - > Input signal strapping (loop through) connectors
 - > Signal ground lift switch.
 - > Stereo or bridged operation
 - > Binding post speaker output connection
 - > 1 Watt output indication (2.828 volts).
 - > Output clip indication.
 - > High-quality, close-tolerance components throughout.
-

PROTECTION FEATURES

- > Suppression of inrush current at mains turn-on.
- > Input muting at turn-on.
- > Input overvoltage protection.
- > Radio-frequency interference suppression.
- > Short-circuit protection.
- > High overload mains fuse.
- > Internal, independent DC supply rail fuses.
- > Layout, grounding, decoupling and componentry have been optimized to provide the user with stability, reliability and longevity.

CONTROLS, CONNECTORS & INDICATORS

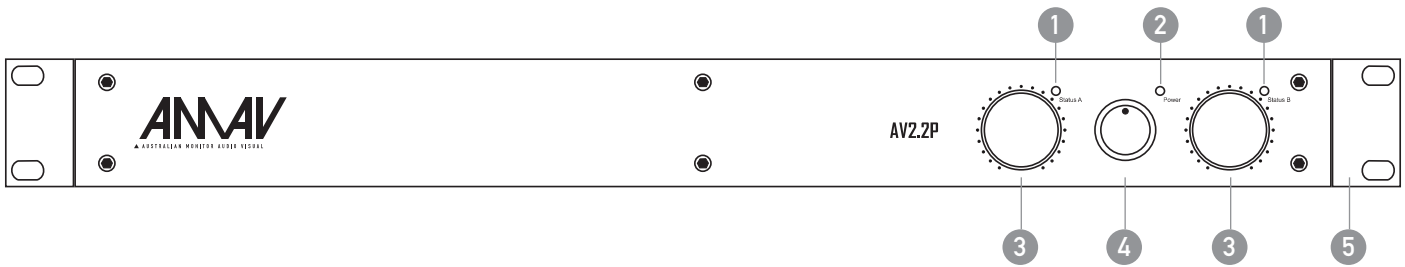

Front Panel

The AMAV AV2.2P/AV2.4P amplifiers differ only slightly in their size and share the same features on their front panels. Figure 1 shows the panel layout of an AV2.2P. It is similar to the AV2.4P. The functions of the controls and indicators are as follows:

1 Status Indicators for Channels A and B

These are dual colour LEDs which indicate the status of the output stage.

They indicate three levels of operation:

Below 1 watt(unlit)

1 watt and above(green)

Clipping(red)

2 Power ON indicator

This LED will illuminate Blue to indicate that the amplifier is ON and is receiving the mains power.

3 Attenuators for Channels A and B

Level control for the amplifier is provided by potentiometers on the front panel.

There are two such controls, one for each channel.

4 Power ON Switch

Press the switch upwards for power On and downwards for power Off.

5 Rack Ears

The amplifier is supplied with a pair of Rack Ears for mounting the amplifier in a 19" Rack.

CONTROLS, CONNECTORS & INDICATORS

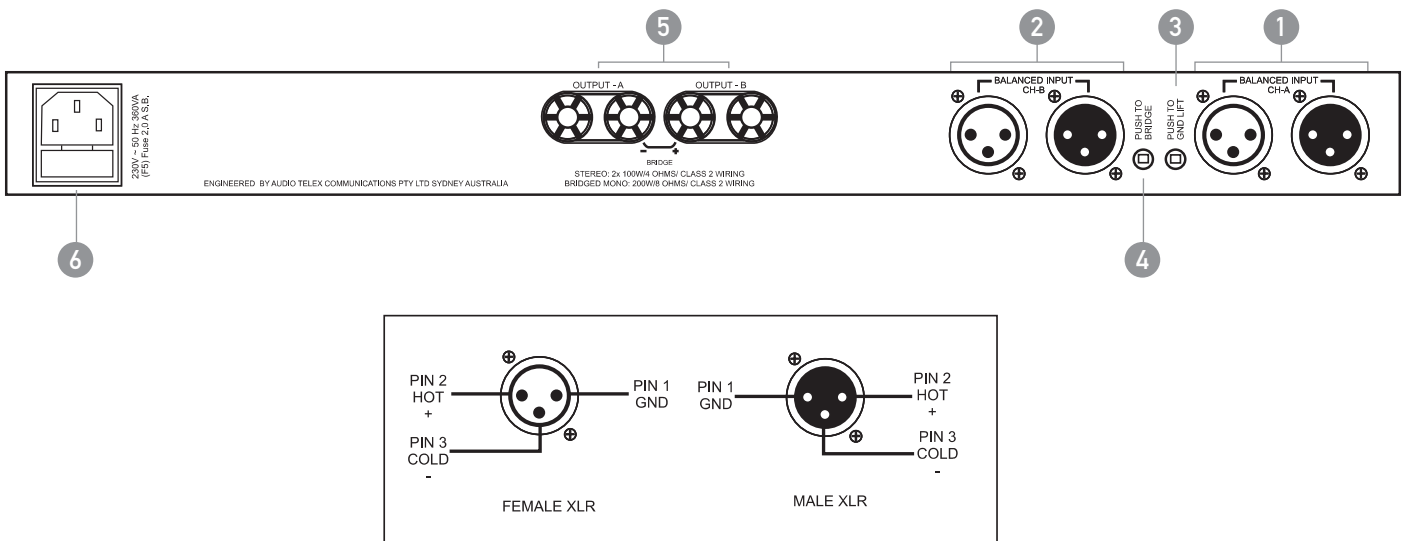

Rear Panel

1 Balanced Input (Channel-A)

There is a pair of XLR connector provided for balanced signal input. A female XLR is wired in parallel with the male XLR for strapping/looping signal between amplifiers.

2 Balanced Input (Channel-B)

Same as Channel - A but for Channel-B input signal

3 Signal GND Lift switch

Pushing this switch IN disconnects signal ground from the input connectors on both channels. It is intended to be used when 'hum' is caused by earth loops (due to different ground potentials between source equipment and the amplifier) or stray magnetic field pick up on the input ground/shield wiring. (It does not interrupt signal ground continuity on the strapping connector).

The amplifier should be turned off before engaging this switch!

4 Bridge Switch

Pushing this switch IN engages the BRIDGE/MONO mode of operation. In this mode the amplifier will only accept signal applied to channel A's input XLR's and the level of both channels will be controlled by channel A's attenuator. The output from channel B will automatically be of the opposite polarity (reversed phase) and speaker termination should be sourced from the red binding-post outputs.

5 Binding Post Outputs

Touch proof binding posts (banana jacks) are provided for speaker output termination with banana plugs or bare wire. The red post is used as positive and the black post is used as negative. For bridge connection, use only the red posts.

6 AC Power Inlet

The amplifier is fitted with an IEC mains inlet connector. Please ensure that the mains lead is of an approved type and is of sufficient current carrying capacity.

Power Requirements

Power consumption for your model AV2.2P / AV2.4P amplifier is indicated on the rear panel for maximum output.

Ensure that mains voltage is the same as the rear panel mains voltage marker (+/- 10%).

Mounting

The amplifier is designed as a table top model as well as for standard 19" rack mounting.

The AV2.2P occupies 1 EIA rack unit (1.75"/44.45mm).

The AV2.4P occupies 2 EIA rack units (3.5"/88.9mm).

The rack mounting ears are packed separately with the amplifier.

The mounting centres for the AV2.2P rack ears are:

Vertical: 1.26" (32mm)

Horizontal: 18.4" (467.36mm)

The mounting centres for the AV2.4P rack ears are:

Vertical: 3" (76.2mm)

Horizontal: 18.4" (467.36mm)

The slots in the mounting flange will accept bolt diameters up to 1/4" (6.35mm).

We recommend that you provide additional support for the amplifier. This support can be provided by secure shelving, support rails or a rear rack mounting strip to match up with the rear rack mount ears provided on your AV2.2P/AV2.4P amplifier.

Cooling

Both the AV2.2P and AV2.4P uses a convection cooling system. The cabinet is designed to it allow the heat sink surface to cool efficiently. One rack space should be provided above and below the amplifier for maximum cooling.

An unrestricted airflow to the unit must be provided. Any restriction of the air flow will cause heat to build up within the amplifier.

If the amplifier is to be operated in an environment where the airflow is restricted (such as in sealed racks) cooling should be supplemented by cooling fans to evacuate the heated air and boost the flow of cool air.

Input Wiring



IMPORTANT: Do not directly connect pin 1 on the amplifier's input or strapping XLR to the amplifier's chassis, speaker ground or power ground!



WARNING: Input signal ground is not to be used as a safety ground (earth)

The input to the amplifier is a balanced 3-pin configuration and requires all three pins to be connected. Only high quality twin-core shielded cable should be used.

When wiring for a balanced source, the connector going to the input of the amplifier should be wired as follows:

Pin 1 =GROUND/ SHIELD.

Pin 2 =HOT(In Phase - non inverting).

Pin 3 =COLD(Reverse Phase - inverting).

When wiring from an unbalanced source you ensure that pin 3 is connected to pin 1 (input ground), either by linking the pins in the input connector or by the source equipment's output wiring.

When wiring for an unbalanced source:

Pin 1 =GROUND/SHIELD,

Pin 2 =HOT(in phase with the amplifier's output),

Pin 3 = GROUND/SHIELD (joins to pin 1).



NOTE: In-line XLR connectors often have a termination lug that connects directly to the chassis of the connector.



IMPORTANT: Do not link this lug to pin 1 at the amplifier's input as it will defeat the amplifier's input grounding scheme.

Output Wiring

When wiring to your speakers always use the largest gauge wire your connector will accept. The longer the speaker lead, the greater the losses will be, resulting in reduced power and less damping at the load. We recommend using a heavy duty, two core flex (four core flex if bi-amping) 10 to 12 gauge (2mm to 2.5mm or 50/0.25 or equivalent) as a minimum.

When terminating to the 4mm binding post (banana jack) output connectors, banana plugs or bare wires can be used. The red terminal is positive and the black terminal is negative (ground).

If running in BRIDGE mode, only the red binding posts are used.

INSTALLATION

Hum Problems

Most equipment is designed for minimum hum when used under ideal conditions. When connected to other equipment, and to a safety earth in an electrically noisy environment, problems may occur.

The three "E"s of hum and hum related noise which can plague your audio system are:

- a) Electrostatic radiation,
- b) Electromagnetic radiation, and
- c) Earth loops

Electrostatic radiation capacitively couples to system elements, causing an interference voltage that mainly affects higher impedance paths, such as amplifier inputs. The source is generally a nearby high voltage, such as a mains lead or a speaker lead. The problem can usually be reduced by moving the offending lead away, or by providing additional electrostatic shielding (i.e. an earthed conductor which forms a barrier to the field).

Electromagnetic radiation induces interference currents into system elements that mainly effect lower impedance paths. Radio transmitters or stray magnetic fields from mains transformers are often the cause of this problem. It is generally more difficult to eliminate this kind of interference, but again, moving the source away or providing a magnetic shield (i.e. a steel shield) should help.

Earth loops can arise from the interfacing of the various pieces of equipment and their connections to various safety earths.

This is by far the most common cause of hum, and it occurs when source equipment and the amplifier are plugged into different points along the safety earth where the safety earth wiring has a current flowing through it. The current flowing through the wire produces a voltage drop due to the wire's resistance. This voltage difference between the amp earth and source equipment earth appears to the amplifier's input as a signal and is amplified as hum.

There are three things you can do to avoid earth loop problems:

Ensure the mains power for the audio system is "quiet" i.e. without equipment on it such as air-conditioning, refrigeration or lighting which may generate noise in the earth circuit.

Ensure all equipment within the system shares a common ground/ safety earth point. This will reduce the possibility of circulating earth currents, as the equipment will be referenced to the same ground potential.

Ensure that balanced signal leads connecting to the amplifier are connected to earth at one end only.

Signal Ground-Lift Switch

When proper system hook-up has been made, you may still have some hum or hum related noise. This may be due to any of the previously mentioned gremlins.

Your AMAV amplifier has a "Signal Ground Lift" switch which disconnects the input ground wiring from the amplifier. A substantial drop in hum and/or hum related noise can result from the judicious use of this switch.

 **NOTE:** If the input ground lift switch is used, you must ensure adequate shielding of the input wiring. If the signal source equipment does not provide adequate shielding (i.e. a definitive connection to ground), you must disconnect the shield from the input connector's ground pin (Pin-1) and re-connect it to the "drain" contact on the input connector. This will ensure the shield on your input wiring actually goes to the amplifier chassis and subsequently to earth.

 **IMPORTANT:** Do not connect pin-1 directly to the drain connection. You will defeat the amplifiers internal grounding scheme and possibly cause instability to the amplifier.

Always ensure that your amplifier is off and the attenuators are down when you engage this switch. This switch should only be used when the amplifier is operated from a balanced signal source.

 **NOTE:** Be wary of quasi-balanced outputs, these are often no more than floating unbalanced outputs.



IMPORTANT: All signal source equipment should be adequately earthed. This not only ensures your safety but everybody else's as well. Faults can and do occur in mains connected equipment where the chassis can become "live" if it is not properly earthed. In these instances, the fault in a "floating" (ungrounded) piece of equipment will look for the shortest path to ground, which could possibly be your amplifier's input. If the fault current is large enough, it will destroy the input to your amplifier and look for the next available path, which may be you!

Before making any connections to your AMAV amplifier, observe the following:

Ensure the mains voltage supply matches the label on the rear panel of your amplifier (+/- 10%).

Ensure that the power switch is OFF.

Ensure that all system grounds (earth) are connected from a common point. Avoid powering equipment within a system from multiple power sources that may be separated by large distances.

Check the continuity of all interconnecting leads to your amplifier; ensure that there are no open or short circuited conductors.

Ensure that the power handling of your load (speakers) can adequately cope with the power output of the amplifier.

Before operating your AMAV amplifier, ensure that:

- The attenuators are at the "OFF" position (fully anticlockwise).
- The GROUND LIFT Switch is not engaged (should be in the "out" position).
- The BRIDGE Switch is not engaged if you are not running the amp in bridged mode.

Powering Up



REMEMBER: The amplifier should be the last piece of equipment that you turn on and the first piece of equipment that you turn off.

We recommend turning the attenuators on your amplifier down when turning the unit on.

Level Matching

The normal operating position for the attenuator is the max position (fully clockwise, no attenuation). In this position the amplifier operates at full gain. Turning the attenuator back (anticlockwise) reduces the input sensitivity.



NOTE: If full power output is required, you should operate your amplifier with the front panel attenuator above the half way (12 o'clock) position, otherwise clipping of the input circuitry and its resultant distortion will occur before full output power is achieved.

Sensitivity

Your amplifier is a linear device operating with a fixed input to output voltage gain (less attenuation). The maximum output voltage swing is determined by the applied mains voltage, load, load type and the duty cycle of the applied signal.

The input sensitivity for your AMAV Series amplifier when the attenuator is at maximum position (fully clockwise) is nominally:

- +4.0dBu (1.23 volts in) for rated power into a 8 ohm load
- +2.2dBu (1.0 volts in) for rated power into a 4 ohm load.

Each channel of your AMAV amplifier has a nominal balanced input impedance of 20kOhms (@1kHz) and should not present a difficult load for any signal source.

Your signal source (i.e. the equipment feeding signal to the amplifier) should have an output impedance of 600 Ohms or lower to avoid unwanted high frequency loss in the cabling.

Input overload occurs at +19.1dBu (7.0 volts)

MAINTENANCE

Only competent or qualified persons should attempt any service or maintenance of your amplifier.

Your AMAV amplifier will need minimal maintenance. No internal adjustments need to be made to the unit to maintain optimum performance.

To provide years of unhindered operation we suggest a maintenance inspection be carried out on a regular basis, say every 12 months or so.

Fuses

Along with rear panel mains fuse, there are four (4) rail fuses provided internally in the unit. These rail fuses are in series with the positive and negative output supply to each amplifier channel and provide overall protection for the output stage. If the amplifier is subjected to heavy use such as short circuits, these fuses will eventually fatigue and may require replacing to ensure they do not fail at an inconvenient time.

⚡ WARNING: Make sure the unit is off and is unplugged from the mains. Give the main filter capacitors time to discharge before removing lids and inspecting the fuses.

You should replace the fuse if the element is sagging or discoloured. Only ever replace with the same type fuse and current rating.

When checking for a failed fuse, do not rely on visual inspection alone. You should use an ohm meter to check continuity.

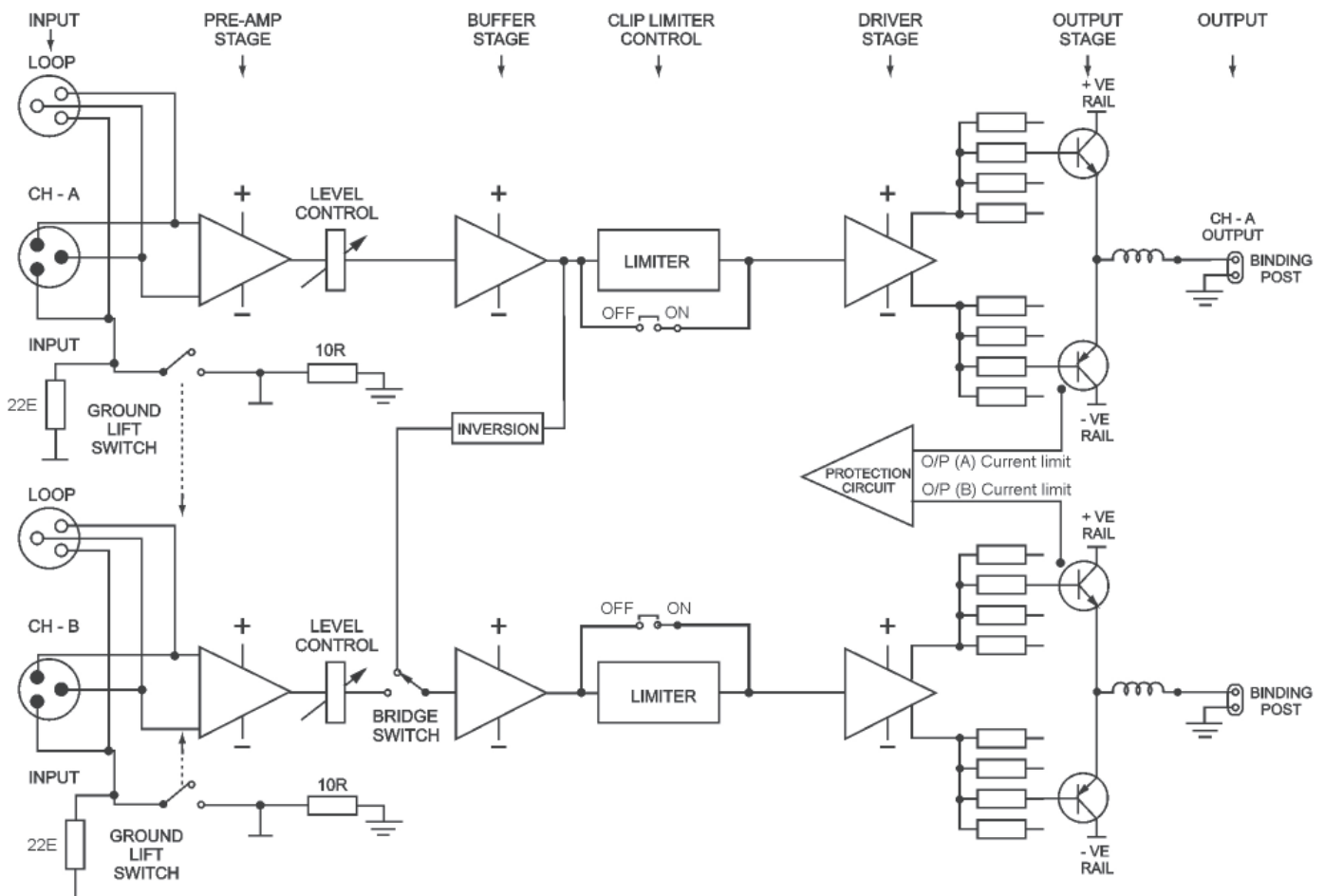

SPECIFICATIONS

Parameter	AV2.2P	AV2.4P
Output Power*		
Both Channels driven : 8ohm :	75W	150W
Single Channel driven : 4ohm :	120W	240W
Both Channels driven : 4ohm :	100W	200W
Bridge mode : 8 ohm :	200W	400W
Voltage Gain	20.0 V/V	28.3 V/V
Output Impedance (1kHz)	0.04 ohm	0.04 ohm
Damping Factor	> 200:1	> 200:1
Slew rate	> 30V/ μ s	> 30V/ μ s
Frequency Response	20Hz ~ 60KHz	20Hz ~ 60KHz
THD (@ 1 KHz)	< 0.02%	< 0.02%
IMD SMPTE (60Hz : 7 KHz 4 : 1)	< 0.03%	< 0.03%
Input Impedance	20kohm	20kohm
Input Sensitivity	1 Vrms	1 Vrms
Input CMRR	> 80dB	> 80dB
S/N Ration : Linear	> 97 dB	> 97 dB
A - Weighted	> 100dB	> 100dB
Crosstalk	> 65 dB	> 65 dB
Dimension (H x W x D) mm	44mm x 482mm x 299.5mm	88mm x 482mm x 299.5mm
Shipping Weight	10 kg	15 kg

* 2ohm loads per channel not recommended
4ohm bridged loads not recommended

AUSTRALIA AND NEW ZEALAND

www.australianmonitor.com.au

SYDNEY

(NSW & ACT SALES)

1 Clyde Street
Silverwater
NSW 2128
Private Bag 149
Silverwater NSW 1811
Phone: (02) 9647 1411
Fax: (02) 9648 3698
Email:
nsw@audiotelx.com.au

MELBOURNE

(VIC & TAS SALES)

22/277
Middleborough Road
Box Hill VIC 3128
PO Box 151 Blackburn
South VIC 3130
Phone: (03) 9890 7477
Fax: (03) 9890 7977
Email:
vic@audiotelx.com.au

BRISBANE

(QLD SALES)

42 Commercial Road
Fortitude Valley
QLD 4006
PO Box 871 Fortitude
Valley QLD 4006
Phone: (07) 3852 1312
Fax: (07) 3252 1237
Email:
qld@audiotelx.com.au

ADELAIDE

(SA & NT SALES)

31 Walsh Street
Thebarton
SA 5031
PO Box 157
Hindmarsh SA 5007
Phone: (08) 8352 4444
Fax: (08) 8352 4488
Email:
sa@audiotelx.com.au

PERTH

(WA SALES)

3/11 Howe Street
Osborne Park WA 6017
PO Box 1281
Osborne Park BC
WA 6916
Phone: (08) 9228 4222
Fax: (08) 9228 4233
Email:
wa@audiotelx.com.au

AUCKLAND

(NZ SALES)

9C Piermark Drive
Albany 0752
New Zealand
PO Box 300-512
Albany 0752
Phone: (09) 415 9426
Fax: (09) 415 9864
Email:
sales@audiotelx.co.nz

EUROPE / ASIA / MIDDLE EAST

www.australianmonitor.com.au

INTERNATIONAL SALES

1 Clyde Street Silverwater NSW 2128 Australia
Private Bag 149 Silverwater NSW 1811
Phone: (02) 9647 1411
Fax: (02) 9648 3698
Email: international@audiotelx.com.au